

High brightness UL LED Panel Light

LVT-PL6060-40

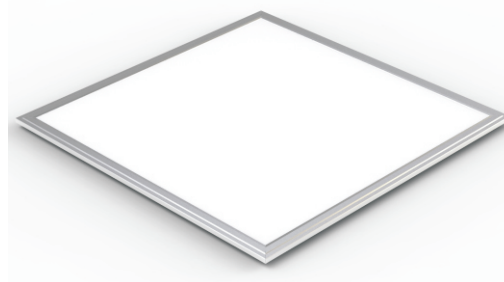

Features



1. The Luminance uniformity of the emitting surface is over 85%.
2. All sides are lined with LED to ensure optimal illumination.
3. High light output and reduced energy consumption of up to 50%.
4. Over 50'000 hours life expectancy.
5. Wide angle of deflection with even light distribution.
6. No start-up time, no flickering, no humming.
7. High efficiency (95%) constant current driver with built in overheat protection that remains stable at a wide range of input voltages.
8. Independent LED circuit prevents complete blackout in case an LED fails.
9. Environmentally friendly, no mercury and no lead.
10. Causes no electromagnetic interference.

Applications



- Hotels
- Conference / Meeting rooms
- Factories & Offices
- Commercial Purposes.
- Residential / Institution Buildings
- Schools, Colleges & Universities
- Hospitals
- Places where energy saving and high color rendering index lighting are needed.



5000K



4000K

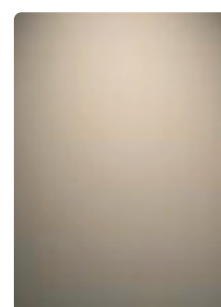

3000K

Specifications

Model #	Color	LED Type	CCT	Rated Power Consumption	CRI	Luminous Flux	R9	Beam Angle	Weight
LVT-PL6060-40	Cool White	SMD 2835	5000K	40W	>80	4011lm	5	120°	4.1Kg
	Nature White	SMD 2835	4000K	40W	>80	3822lm	5	120°	
	Warm White	SMD 2835	3000K	40W	>80	3711lm	5	120°	

Dimensions (Unit: mm/inch)

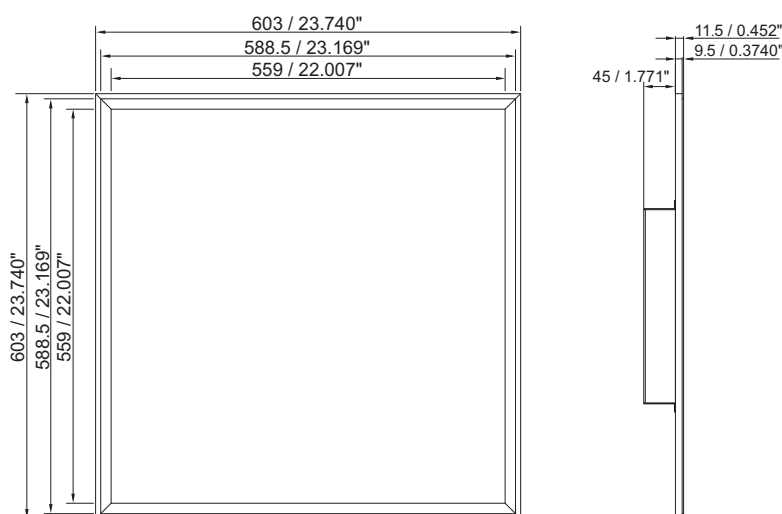

Remark: all dimension tolerance is $\pm 0.5\text{mm}$ unless otherwise noted

Average Illuminance Figure

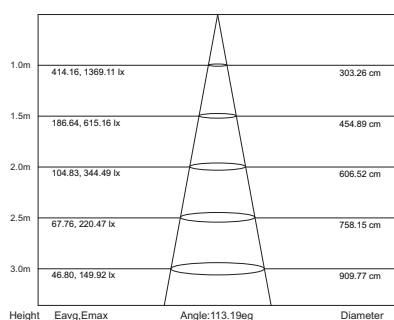

LVT-PL6060-40(CW)

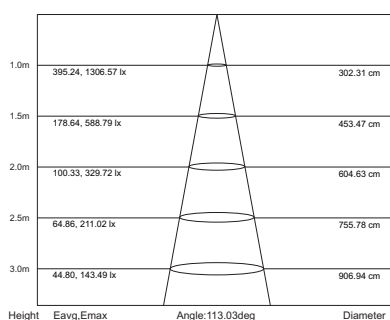

LVT-PL6060-40(NW)

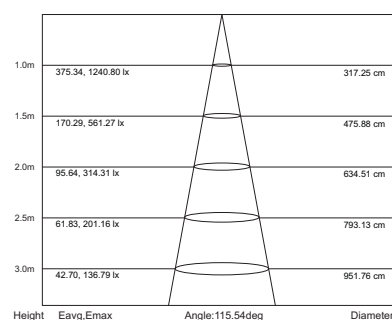

LVT-PL6060-40(WW)

Light Source Test Report

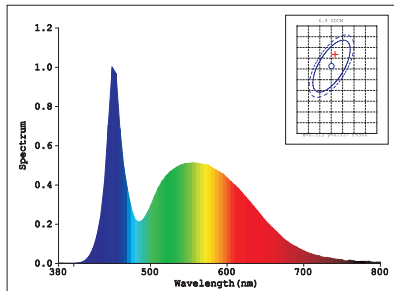

LVT-PL6060-40(CW)

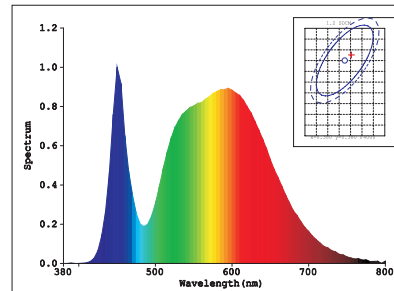

LVT-PL6060-40(NW)

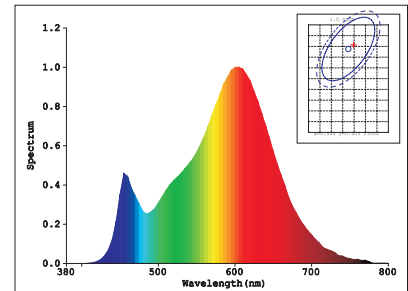

LVT-PL6060-40(WW)

Driver data Sheet

Driver data	LVT-PL6060-40	LVT-PL6060-40N
Range Input voltage	AC100-277V / 127-431VDC	AC100-277V
Frequency(Hz)	50/60Hz	50/60Hz
Input rated voltage	AC100-277V	AC100-277V
Efficiency	≥85%	≥87%
No load wattage	≤1W	≤0.7W
Total load wattage	40W±5%	40W±5%
Power Factor	≥0.9	≥0.9@full load, 90-264Vac
Power Harmonic(THD)	≤20%	≤20%
Full load output voltage	DC25.2~42V	DC25.2~42V
Rated output current	1120mA	1120mA
Out current range	1120mA±5%	1120mA±5%
Out voltage ripple	≤2V	≤0.12V
Hold-up time	10ms max	10ms max
Tolerance	±5%	±5%
Current output tolerance	±5%	±5%
Dimming range	8%~100%	—
Dimmer	0-10V/PWM	—
Withstand voltage	AC3750V	AC3750V

Installation Instructions

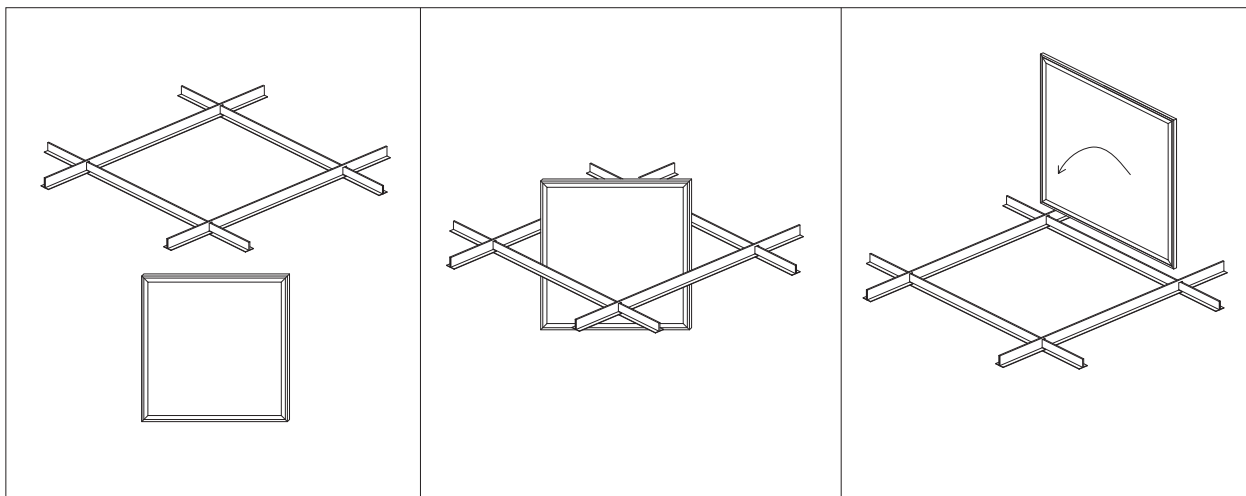
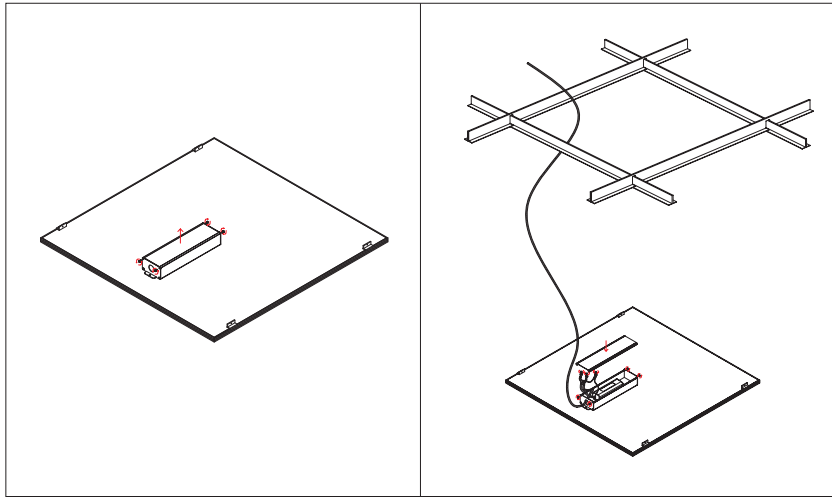

Install instruction

1. Turn off the power switch.
2. Connect the output-terminal with utility power (AC 100-277V) by using wiring unit, make certain that no copper wire is bared.
3. Connect the output-terminal DC plug of current driver with the lamp's DC plug, insure this connection secure.
4. Put the panel light and current driver to the suitable place by convenient installation.
5. Turn on the power switch.

Loevet Lighting CO., Ltd Warranty

Shenzhen Loevet Lighting CO., Ltd offers this product against defects in material or workmanship for 5 years warranty from the date of purchase. If this product is determined to be defective, Loevet will repair or exchange for client's option. This warranty does not cover cosmetic damage or damage due to the acts of God, accident, misuse, abuse, negligence, commercial use, or modification of any parts of the products. This warranty does not cover damage due to improper operation or maintenance, connection to improper voltages supply or attempted repair by anyone than a facility authorized by Loevet to service the product.

Repair or replacement as approved under this warranty is additional compensation of the customer. Loevet should not be liable for any accidental or consequential damages and any explicit or potentially responsible for the warranty of this product, except to the extent prohibited by applicable law, any potential nature of merchantability or fitness for a particular purpose within the warranty period is limited in duration.

The exclusion or limitation of incidental or consequential damages all not allow on some states. Or allow limitations on how long an implied warranty lasts. So above limitation and exclusion are maybe not apply to you. The guarantee has showed detail legal right and you may have other right which vary from state to state.

Only may change, amend or modify the terms of this limited warranty and any such change amendment or modification shall be in writing and signed by Loevet. To obtain warranty service and shipping information call +866-755-33134683 or email info@lvt-lighting.com. You must provide proof of purchase on the form of a bill of sale or receipted invoice which is evidenced that the product is within the warranty period to obtain warranty service.

Consumers have legal rights under applicable national legislation governing the sale of consumer goods. Such rights are not affected by the warranties provision outlined in this document.